



SELECTED PROCEEDINGS

The road traffic management urban network for low carbon society

HIROAKI INOKUCHI, KANSAI UNIVERSITY, 3-3-35, YAMATE-CHO, SUITA, OSAKA, 564-8680, JAPAN
TAKAMASA AKIYAMA, KANSAI UNIVERSITY, 3-3-35, YAMATE-CHO, SUITA, OSAKA, 564-8680, JAPAN

This is an abridged version of the paper presented at the conference. The full version is being submitted elsewhere.
Details on the full paper can be obtained from the author.

ISBN: 978-85-285-0232-9

13th World Conference
on Transport Research

www.wctr2013rio.com

15-18
JULY
2013
Rio de Janeiro, Brazil

unicast

The road traffic management urban network for low carbon society

Hiroaki Inokuchi¹, Takamasa Akiyama²

^{1,2}Kansai University, 3-3-35, Yamate-cho, Suita, Osaka, 564-8680, Japan

Email for correspondence: hiroaki@inokuchi.jp

Submission for track: G: Transport Planning, Policy and Management

1. Introduction

The realization of the low-carbon society becomes the problem in the world. In Japan, approximately 19% of the 124 million tons of CO₂ emitted in 2011 were from the transport sector [Japan Center for Climate Change Actions (2013)]. In the CO₂ emissions in the transport sector, the ratio of automobiles is high. Various countermeasures such as the popularization of the hybrid vehicle or the electric vehicle (EV) were initiated to reduce these CO₂ emissions. However, the amount of exhaust gas emission is varied from the state of the road traffic. Therefore, it is important to estimate a greenhouse gas emission from each vehicle.

The annual CO₂ emissions of the whole country can be estimated from the gasoline consumption. However, this method cannot use for the prediction of the effect of transport policies. The estimation of the CO₂ emission of the micro-level is not easy due to fluctuate by running conditions such as running speed, acceleration.

For the prediction of the effect of transport policies, a traffic assignment model or a traffic simulation model are used mainly. The traffic assignment model can estimate the traffic volume for wide area, but the detailed traffic behavior cannot reappear. Therefore, the estimation of the CO₂ emission reduction effect with a local transport policy is difficult. In contrast, the microscopic traffic simulation model can be analyzed the detailed traffic behavior. Therefore, a microscopic traffic simulation model is used in this study. This study aims to evaluation transport policies realizing a low-carbon society.

2. Environmental Assessment Method of the Transport Sector

The environmental impact of the road traffic varies by a traffic condition. For example, Figure 1 shows the relationship between the average speed and the CO₂ emission [Ohshiro et al. (2001)].

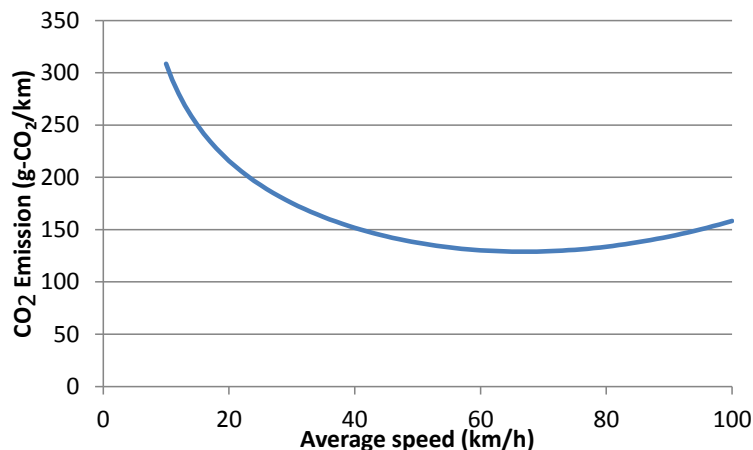

Figure 1 – The relationship between the average speed and the CO₂ emission

The urban environmental management method is proposed with the GIS system [Fedra (1999)]. This graph shows the emission per 1 km run. This relationship is non-linear. Particularly, the CO₂ emission increases when the average speed is low. Figure 2 shows the calculated results of the traffic volume and the average speed every 15 minutes using the traffic simulation model.

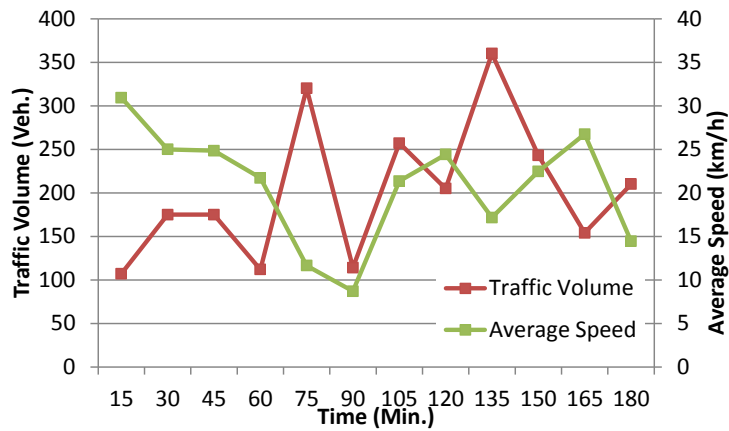

Figure 2 – The time series change of traffic volume and average speed

The traffic volume and the average speed are varied by the time zone. Particularly, a decline in the average speed at 90 minutes is remarkable.

When a traffic assignment model is used, the change at time is not considered. Namely, the number of the calculated traffic volume is one in a road section. In the case of the road section shown in Figure 2, estimated results for three hours are shown in Table-1.

Table 1 – Estimated results for three hours

| | | | |
|-------------------|-----------|-----------------------|-----------|
| Traffic volume | 2432 veh. | Total travel distance | 665.3 km |
| Total travel time | 2230 min. | Average speed | 17.9 km/h |

Here, the CO₂ emission is estimated based on the traffic volume and the average speed. When a traffic simulation model is used, the traffic volume and the average speed are varied in time. Therefore, the CO₂ emission is varied in time. The time series change of the CO₂ emission using the traffic simulation model is shown in Figure 3. For example, the maximum of the traffic volume is at the time band of 135 minutes (Figure 2). However, the maximum of the CO₂ emission is at the time band of 75 minutes (Figure 3). That is because the average speed of the time band of 75 minutes is lower than the time band of 135 minutes. In this case, the CO₂ emission of three hours is 141.6 kg-CO₂. On the other hand, the CO₂ emission is calculated 151.8 kg-CO₂ based on Table 1 (average speed for three hours). The CO₂ emission is 7.2 % larger than the estimated value using the traffic simulation model. Therefore, it may be said that it is more suitable to use a traffic simulation model in the situation that a traffic condition changes at time.

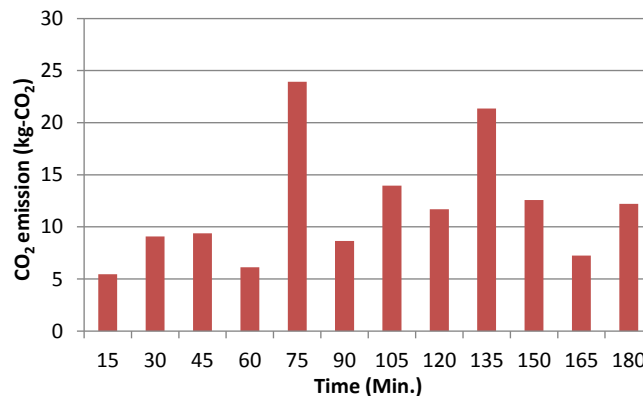

Figure 3 – The time series change of CO₂ emission

3. Environmental Assessment Method Using the Traffic Simulation

The traffic simulation model to estimate the environmental impact is developed. Firstly, the estimate model for the CO₂ emission is developed. Secondly, the microscopic road traffic simulation model is developed.

3.1 The estimate model for the environmental impact

In this study, the CO₂ emission model is developed using the data which the measured CO₂ emission in real field [Inokuchi et al. (2006)]. The CO₂ emission varies according to a vehicle. Therefore, an estimate model is developed each vehicle type. In an existing study, it is shown that the amount of CO₂ emission receives the influence of the travel speed and the acceleration etc. Therefore, explanatory variables of the estimate model are used the travel speed, the acceleration and the deceleration. In this study, the linear regression model shown in equation (1) is used.

$$D_{CO_2} = a \cdot V + b \cdot \delta_{Acc+} \cdot Acc + c \cdot (1 - \delta_{Acc+}) \cdot Acc + d \quad (1)$$

where,

D_{CO_2} : CO₂ emission (g / s), V : Travel Speed (km / h), Acc : Acceleration (km / h / s),

a, b, c, d : parameters,

$$\delta_{Acc+} = \begin{cases} 1: \text{if } Acc \geq 0 \\ 0: \text{if } Acc < 0 \end{cases}$$

The estimate model is developed for six vehicle types. Parameters of estimate models are shown in Table 2. As a truck vehicle, the vehicle with the diesel engine is used.

Table 2 – Parameters of CO₂ emission estimate models

| | Medium-sized truck (diesel engine) | Small-sized truck (diesel engine) | Medium-sized passenger car (gasoline engine) | Small-sized passenger car (gasoline engine) | Light-sized car (gasoline engine) | Hybrid passenger car (gasoline engine) |
|-------------------------|------------------------------------|-----------------------------------|--|---|-----------------------------------|--|
| d (constant) | -0.015 | 0.027 | 0.297 | 0.726 | 0.386 | -0.048 |
| a (speed) | 0.141 | 0.212 | 0.0430 | 0.00574 | 0.0123 | 0.024 |
| b (acceleration) | 0.171 | 0.017 | 0.00996 | 0.0233 | 0.102 | 0.134 |
| c (deceleration) | 0.012 | 0.002 | 0.00996 | 0.0271 | 0.0226 | 0.057 |
| No. of samples | 15,980 | 16,930 | 14,973 | 12,821 | 15,697 | 26,285 |
| Correlation coefficient | 0.61 | 0.63 | 0.79 | 0.45 | 0.65 | 0.49 |

3.2 The traffic simulation model

The outline of the traffic simulation model is described. A lot of traffic simulation models are developed in the world. In this study, the microscopic road traffic simulation model CaTS (Car-following-based Traffic Simulation) developed originally is used. The outline of the traffic simulation model CaTS is shown in Table 3. Feature of this model is to reproduce the movement of the vehicle in detail including the crossing section.

Table 3 – The outline of the traffic simulation model CaTS

| | |
|-------------------------------------|--|
| Expression of vehicle and unit time | Calculate every one vehicle for 0.1 seconds |
| Route choice model | <ul style="list-style-type: none"> - The shortest path is calculated from the average of travel time of the unit for 15 minutes. - The calculation of the shortest path is carried out every one minute. - The shortest path to the destination is chosen at the time of an inflow in each link. |
| The model of crossing section | <ul style="list-style-type: none"> - The case of a left turn, going straight: The travel speed is decided using a speed decision model based on the distance between the vehicles of the inflow block. - The case of a right turn: When an oncoming car has to slow down, the vehicle stops in the central part of crossing. Otherwise, the travel speed is decided like the case of a left turn and going straight. |
| The model of lane changing | <ul style="list-style-type: none"> - For passing the vehicle: The decision making in having lane-changing or not is executed based on desired travel speed (regulation speed) and the travel speed of preceding vehicle. - For left turn, right turn: The decision making of the lane-changing is executed based on the safety margin. |

The procedure of calculating the model is shown in Figure 4. The points of the procedure are 1) the travel speed of all vehicles is decided, 2) each vehicle position is decided from the travel speed.

The road network model is composed of 'Block', 'Lane' and 'Vehicle', shown in Figure 5. The road network is expressed by combining the Block, which is one-way link shown in Figure 6. The signals and the intersections are supposed to accompany end of the Lane. For the Block, it has data such as signal indication pattern, link length and distance in the intersection, regulation speed, number of lanes etc. It has information such as the pointer of the head vehicle and the tail vehicle of the lane, the possibility of turn to right or left etc. in the Lane. Data such as the pointer of the preceding vehicle, the pointer of the following vehicle, speed, running position, departure and arrival point is provided to individual Vehicle.

The car-following model that is the important element of the microscopic road traffic simulation model is described. In this simulation model, the car-following model by using the fuzzy neural network model developed in an existing study is used [Inokuchi et al. (1999)]. Various factors such as the travel speed, the distance between vehicles, the preceding vehicle's acceleration, and the state of the road are considered while driving. In this model, the explanatory variables are used the travel speed of one second before and the distance between two vehicles of one second before. Here, the reason to use the speed and the distance of one second before is to consider driver's response delay time.

In this study, the fuzzy neural network model is used. Three kinds of membership functions of High, Middle, and Low are set per each explanatory variable. Therefore, nine fuzzy rules are set. The fuzzy rules are shown in Figure 7. The VEL shows the travel speed, the DST shows the headway, and the ACC shows the acceleration.

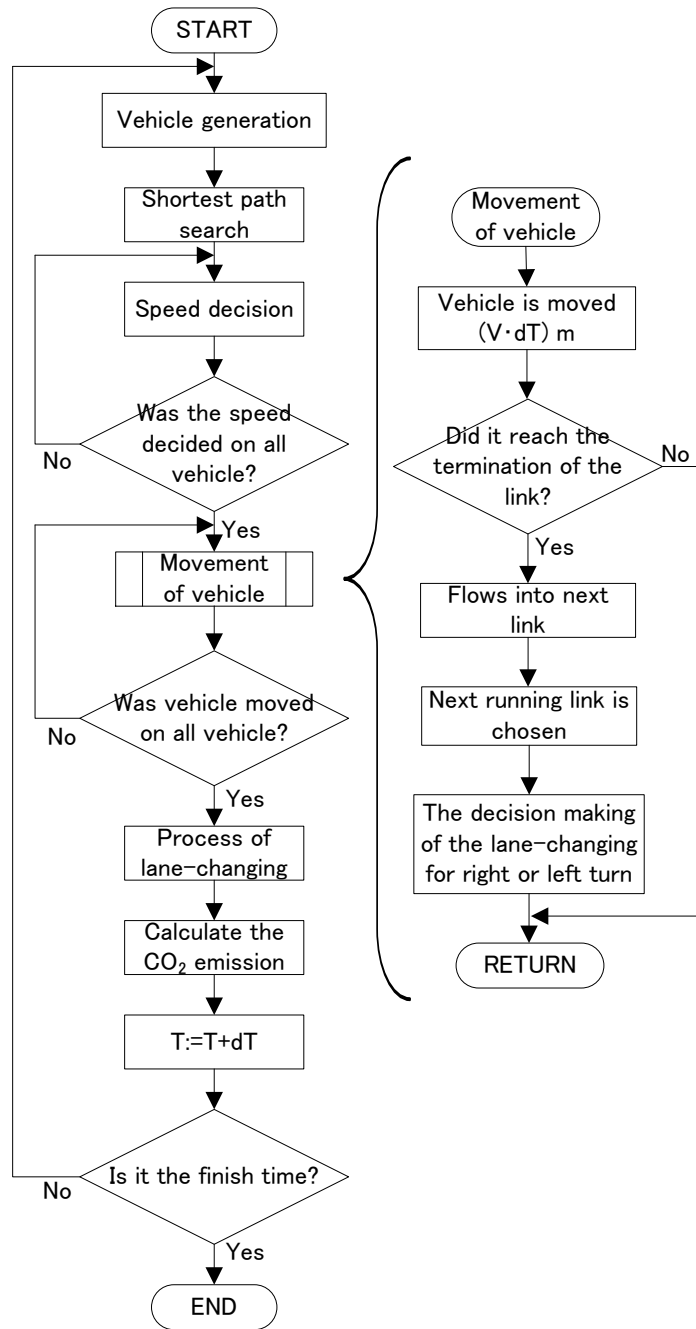

Figure 4 – The flowchart for the CaTS simulation model

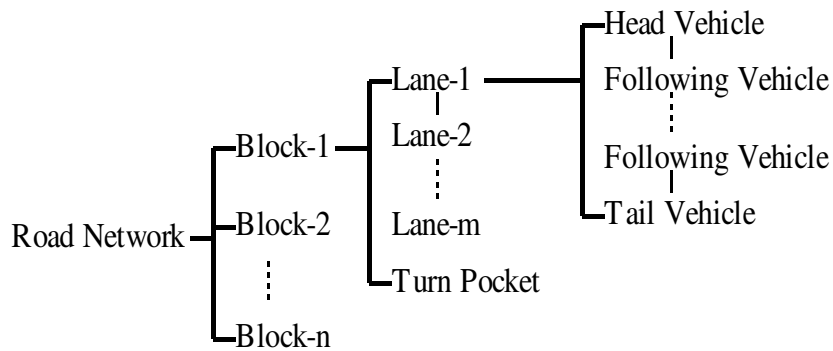

Figure 5 – The structure of the road network model

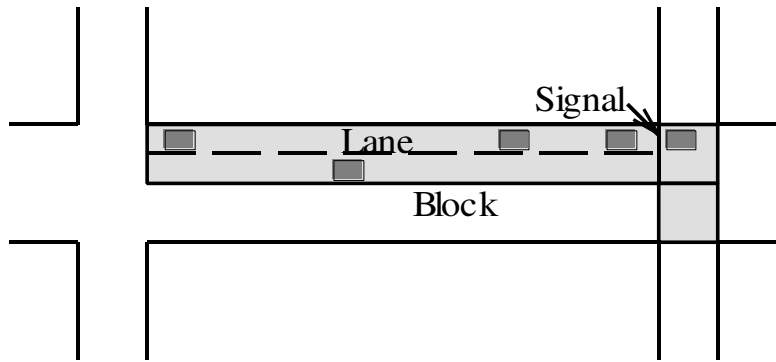

Figure 6 – The road network model

- Rule-1 : If VEL is Low and DST is Short then ACC is Middle.
- Rule-2 : If VEL is Low and DST is Middle then ACC is High.
- Rule-3 : If VEL is Low and DST is Large then ACC is High.
- Rule-4 : If VEL is Middle and DST is Short then ACC is Low.
- Rule-5 : If VEL is Middle and DST is Middle then ACC is Middle.
- Rule-6 : If VEL is Middle and DST is Large then ACC is High.
- Rule-7 : If VEL is High and DST is Short then ACC is Low.
- Rule-8 : If VEL is High and DST is Middle then ACC is Low.
- Rule-9 : If VEL is High and DST is Large then ACC is Middle.

Figure 7 – The fuzzy rules of the car-following model

The structure of the neural network model is shown in Figure 8.

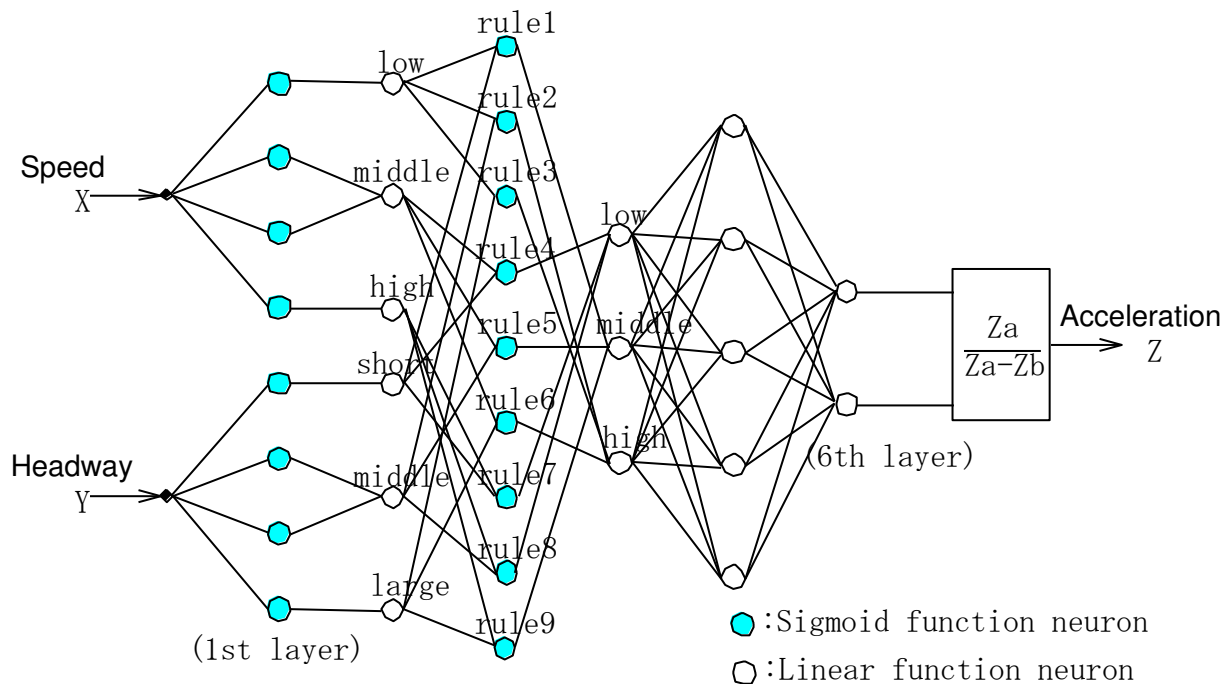

Figure 8 – The structure of the car-following model

The neural network is composed of six layers. The first and second layers are expressed the membership function of the explanatory variables. In the third and fourth layers, the fuzzy rules are applied. The acceleration is output by these calculations. The parameters of this model are given by the actual measuring data. By using a fuzzy neural network model, the fuzziness of the vehicle driver can be considered. In addition, the development of the model to match actual survey data is possible.

4. Evaluation of the Transport Policy

The road traffic simulation model is applied to the road network. Firstly, the data to use the calculation is described. Secondly, the calculation results are shown.

4.1 The data used in the simulation

In this study, the road network is set for center of Kyoto City. The road network is shown in Figure 9. The area of Kyoto City is 827.9km². Because the calculation area is 60.4 km², it is the area of 7.3 % of whole Kyoto City. The road network shown in Figure 9 is comprised of 518 links (road section) and 237 nodes. The car OD table is set based on the person trip survey (2000). Evaluation time is from 7:00 to 10:00 in peak time of traffic.

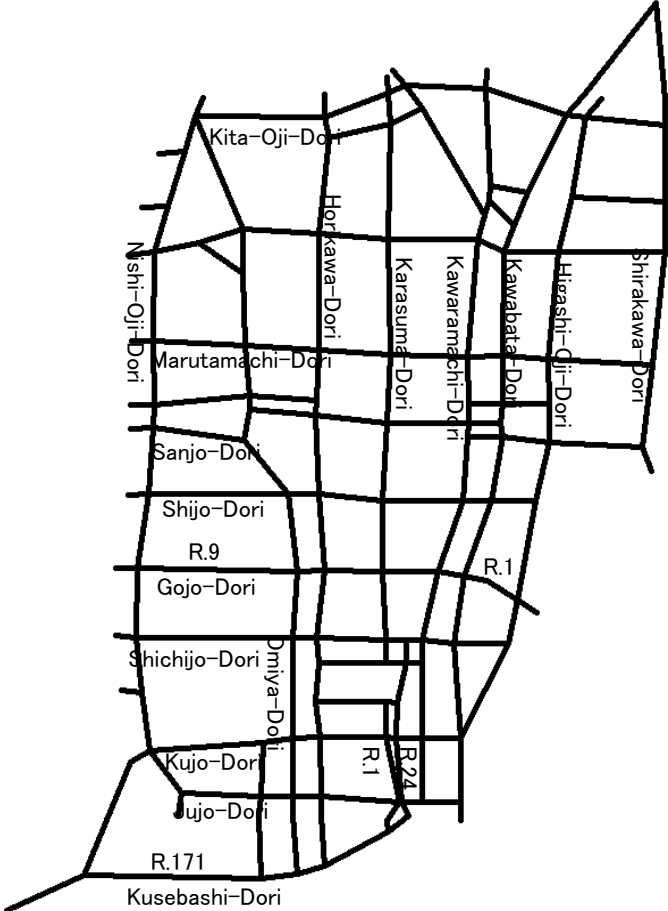

Figure 9 – The road network

4.2 Calculation of the traffic state

As a calculation result of the traffic simulation, the data such as the travel speed, the travel time for each vehicle are provided. A basic traffic state is described.

The distribution of average speed from 8:00 to 8:15 that are the peak time of the area is shown in Figure 10. The road section with less than 10 km/h of average speed is 29 %. On the other hand, the road section flowing relatively smooth with more than 30 km/h of average speed is 30 %. There are many road sections having low average speed in Minami Ward, Shimogyo Ward and Nakagyo Ward.

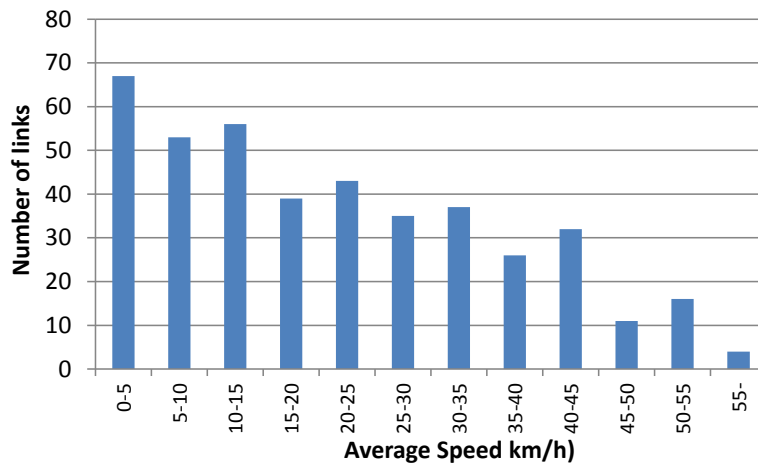

Figure 10 – The distribution of average speed (8:00 – 8:15)

4.3 Calculation of the environmental impact

The amount of the environmental impact is estimated. The CO₂ emission of each zone is calculated based on the CO₂ emission of each link. The CO₂ emission of each link is calculated based on the CO₂ emission of each vehicle with the traffic simulation model (7:00-10:00). The CO₂ emission of each zone is shown in Figure 11.

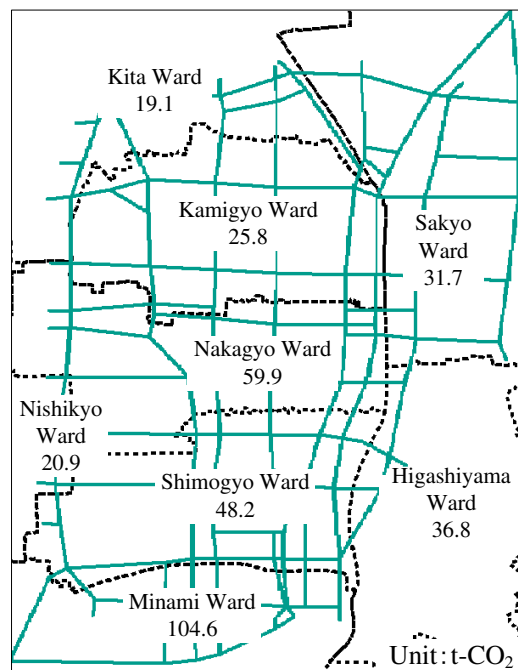

Figure 11 – The CO₂ emission of each zone

The CO₂ emission of Minami Ward which located industrial section is largest. In addition, the CO₂ emission of Nakagyo Ward and Shimogyo Ward is larger due to the traffic congestion.

4.4 The effect of introducing the transit mall

An effect of introducing the transit mall is analyzed as an example of the transport policies toward the low-carbon societies. In Kyoto City, the social experiment of introduction the transit mall was carried out in 2007. This social experiment is to control the vehicle between Shijo-Kawaramachi and Shijo-Karasuma expects the route bus and the taxi. In this study, the effect of introducing the transit mall is analyzed in reference to this social experiment.

In this analysis, the vehicle is controlled between Shijo-Kawaramachi and Shijo-Karasuma shown in Figure 12. In this situation, some trip makers switch from a car to a public transport. Therefore, the car OD traffic is reduced in conjunction with the transit mall area.



Figure 12 – The introduction of the transit mall

On the neighboring roads including the Gojo-dori, a detour vehicle is seen. The relationship between the ratio of reducing the OD traffic and the average speed at Gojo-dori is shown in Figure 13. When there are few reduction ratios of the OD traffic, the congestion occurs by the detour vehicle. Therefore, the average speed decreases than the case not to introduce a transit mall policy. Particularly, the average speed decreases 4.5 km/h when the reduction ratio is 0 %. Therefore, the traffic congestion of the neighboring road section is worse when they cannot anticipate switch from a car to public transport.

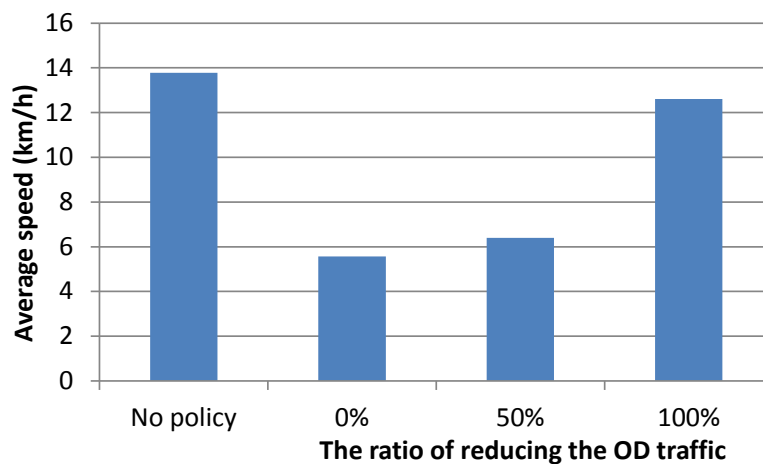

Figure 13 – The relationship between the ratio of reducing the OD traffic and the average speed (Goji-dori)

The relationship between the ratio of reducing the OD traffic and the CO₂ emission is shown in Figure 14. When the ratio of reducing the OD traffic is small, the CO₂ emission increases

by introduction of the transit mall. This originates in that the traffic congestion of neighboring road section increases by the detour traffic. When the reducing rate is 0 %, the CO₂ emission increases 1.0 t-CO₂ for 3 hours. On the other hand, the reduction of the CO₂ emission is expected if the ratio of reducing the OD traffic is more than 50 %. Therefore, it leads to environmental degradation by introducing the transit mall when it is not promoted to switch from a car to public transport.

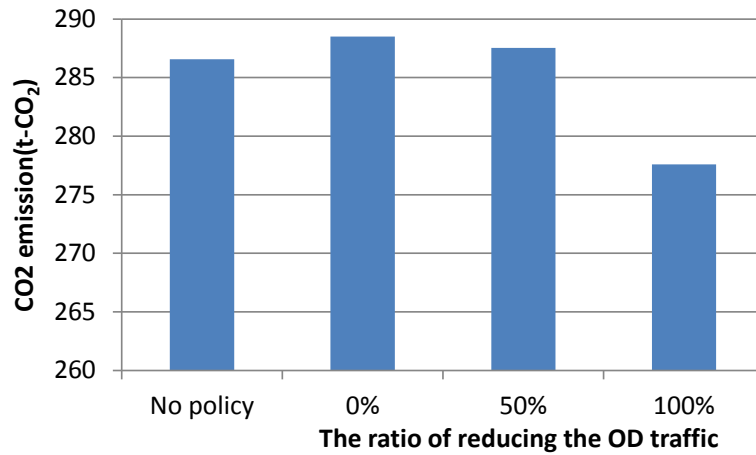

Figure 14 – The relationship between the ratio of reducing the OD traffic and the CO₂ emission

4.5 The effect of introducing the smart zone

The effect of introducing the smart zone is examined as a transport policy toward the low-carbon society. In this study, the smart zone is defined a chief area aiming at reduction of the quantity of environmental impact. This includes not only the transport sector but also the social welfare sector etc. In this study, it is supposed that the ratio of Electric Vehicle (EV) of a smart zone is higher.

The EV does not exhaust the CO₂ directly. In addition, the data of the relations with the running pattern and the electric consumption are not provided enough. Therefore, the electric consumption factor (124 Wh/km) which measured at JC08 test mode is used. In addition, the emission factors are set to CO₂ : 0.450 kg-CO₂/kWh [Kansai Electric Power(2012)].

In this study, the Nakagyo Ward is set to a smart zone shown in Figure 15.



Figure 15 – The smart zone setting

The ratio of EV in the smart zone is set to five cases (from 5 % to 20 %). This replaces the

constant ratio of trip to arrive and depart in a smart zone with EV. Relationship between the ratio of the EV and the CO₂ emission in smart zone is shown in Figure 16.

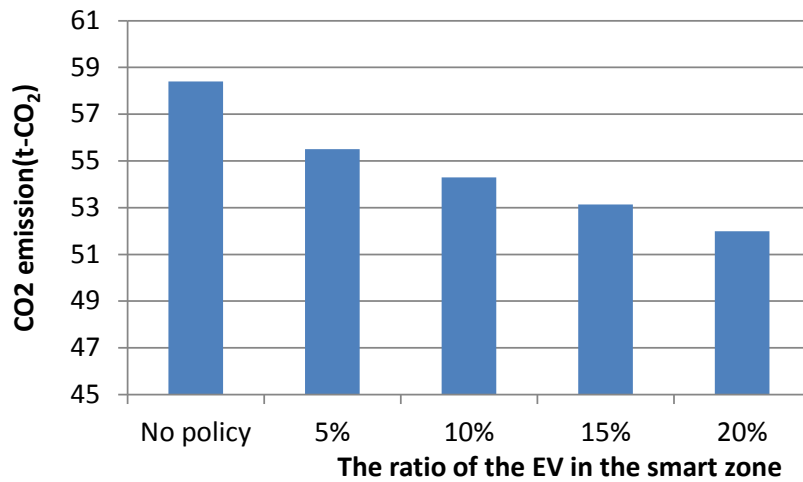

Figure 16 – The relationship between the ratio of the EV and the CO₂ emission in smart zone

With the increase of the EV vehicle ratio, the CO₂ emission decreases. Specifically, the CO₂ emission can anticipate 11 % of reduction at the EV ratio of 20%.

Relationship between the ratio of the EV and the CO₂ emission of the whole road network is shown in Figure 17.

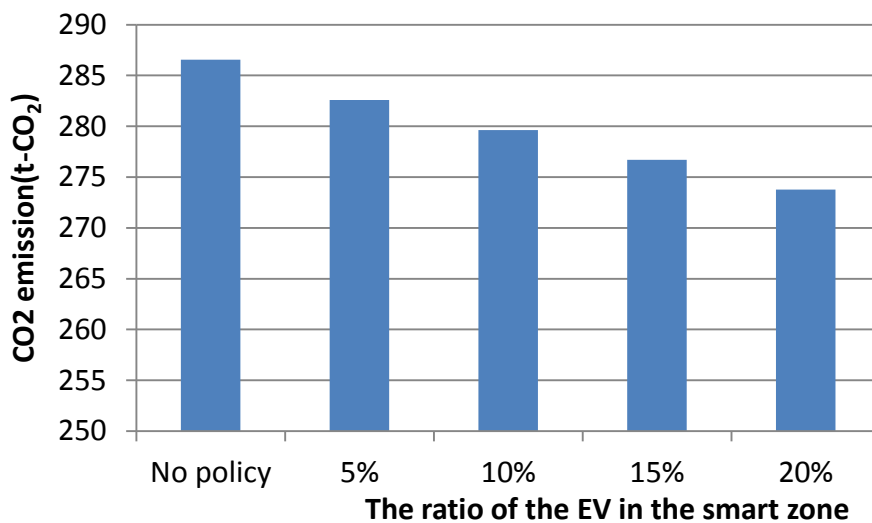

Figure 17 – The relationship between the ratio of the EV and the CO₂ emission

Because the EV runs outside of the smart zone, the reduction of the CO₂ emission is anticipated outside of the smart zone. The CO₂ emission can reduce 4.5 % at the EV ratio of 20%.

5. Concluding Remarks

In this study, a reduction effect of the environmental impact by introducing the transport policy is evaluated using a microscopic road traffic simulation model. The results of the study are shown in below.

- 1) The method to evaluate the environmental impact using a traffic simulation is shown. This traffic simulation model is involved the estimate model of environmental impact.

- 2) An introduction effect of the transit mall is examined as an example of the transport policies. As a result, the traffic congestion at the neighbouring road section occurred, when there is little reduction of the car traffic. Moreover, this leads to the increase of the CO₂ emission.
- 3) The effect of introducing the smart zone is examined as a transport policy toward the low-carbon society. As a result, the CO₂ emission can anticipate 11 % of reduction at the EV ratio of 20%. Because the EV runs outside of the smart zone, the reduction of the CO₂ emission is anticipated outside of the smart zone.

Further work is to examine transport policies in detail toward to the low-carbon society.

References

- Fedra, K. (1999). Urban environmental management: monitoring, GIS, and modelling, Computers, Environment and Urban Systems, Vol.23, No. 6, pp.443-457.
- Inokuchi, H., Kawakami, S and Ogino, H.(1999). Development of microscopic road traffic simulation model by using fuzzy neural network. Infrastructure planning review, Vol. 16, 911–918.
- Inokuchi, H., Kawakami, S., Ogino, H. and Noda, K. (2006). Development of a Prediction Method of Automobile Exhaust Gas Quantity Based on Driver Attributes, 13th World Congress on Intelligent Transport Systems (CD-ROM).
- Inokuchi, H., Akiyama, T. (2010). Practical Estimation of Carbon Dioxide Emission for Automobile by Neural Network , SCIS & ISIS 2010, SA-D5-3.
- Inokuchi, H., Akiyama, T., Okushima, M. (2010). Evaluation of Environmental Improvement Policy on Urban Network Considering Hybrid Vehicle, Annual Report on Transportation Economics 2009, pp.35-44.
- Inokuchi, H., Akiyama, T (2010). Evaluation of Environmental Improvement Policy in an Urban Network using Road Traffic Simulation,12th WCTR, No.1573.
- Japan Center for Climate Change Actions (2012). The greenhouse gas emission in Japan, http://www.jccca.org/chart/chart04_01.html.
- Kansai Electric Power (2012). Corporate Social Responsibility Report 2012, pp.37-56.
- Ohshiro, N., Matsushita, M., Namikawa, Y., Ohnishi, H. (2001). Fuel consumption and emission factors of carbon dioxide for motor vehicles, Civil engineering journal, Vol.43, No.11, pp.50-55.